

Article number: 12705000050100

Description: KLEE-coil 705 000 050.100
M5 Unhardened

Measures

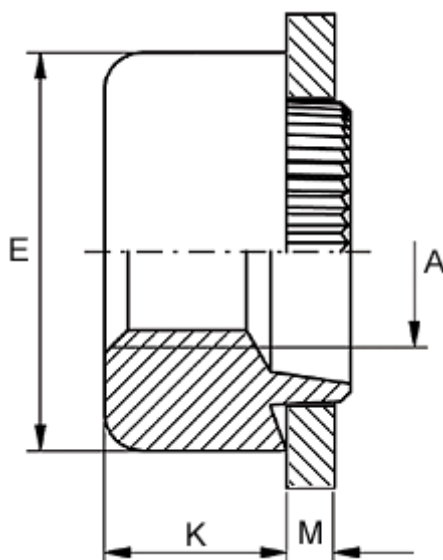

Female thread A	= M5
Height K	= 3.0
Outer diameter E	= 11.0
Plate thickness	= 1.1 to 1.3
Recommended bore diameter for extreme load	= 8.0
Recommended bore diameter for normal use	= 8.0